



---

**PX/QX/RX Version 4.20**

**User Manual**

**Issue B**

**Contents**

<b>CONTENTS</b> .....	<b>2</b>
<b>INTRODUCTION</b> .....	<b>5</b>
EVENT LOG .....	5
AREAS & SET GROUPS .....	5
CIRCUITS .....	5
USER, SET GROUP AND CIRCUIT IDENTIFICATION .....	5
USER CODES .....	6
<b>OPERATOR CONTROLS AND DISPLAYS</b> .....	<b>6</b>
SYSTEM KEYPADS .....	6
MINI KEYPAD .....	6
<i>Cards/Fobs</i> .....	6
DUAL USER CODE OPERATION .....	7
USER CARD+PIN OPERATION .....	7
<b>USING THE SYSTEM</b> .....	<b>7</b>
EASY SET .....	8
HELP .....	8
REMOTE ASSIST .....	8
INCORRECT CODES .....	9
<b>SET</b> .....	<b>10</b>
SETTING FROM A KEYPAD .....	10
SETTING WITH A MINI KEYPAD .....	10
KEYSWITCH/RADIO KEYFOB SETTING .....	11
AUTOMATIC SETTING .....	11
<i>Aborting The Setting Procedure</i> .....	11
SETTING WITH WARNINGS .....	11
EASY SET .....	11
SETTING RESTRICTIONS .....	12
SETTING FAULTS .....	12
DUAL SET (PX250HS ONLY) .....	13
<b>UNSET</b> .....	<b>14</b>
UNSETTING METHODS .....	14
<i>Unsetting from a keypad</i> .....	14
<i>Unsetting with Keypad or Radio Keyfob</i> .....	14
<i>Automatic Unsetting</i> .....	15
UNSETTING WARNINGS .....	15
UNSETTING RESTRICTIONS .....	15
UNSET DELAY (PX250HS ONLY) .....	16
DUAL UNSET (PX250HS ONLY) .....	16
<b>RESET</b> .....	<b>17</b>
MANAGED RESET .....	17
<b>TEST</b> .....	<b>18</b>
<b>ENGINEER</b> .....	<b>19</b>
<b>PIN</b> .....	<b>19</b>
<b>USER</b> .....	<b>20</b>
NAME .....	20
PIN .....	20
CARD .....	21
AUTHORITY .....	21
ACM AUTHORITY (PX ONLY) .....	22

---

<i>Level</i> .....	22
SCHEDULE .....	22
LOCKOUT (PX ONLY).....	23
EXPIRY DATE (PX ONLY).....	23
<b>TEL NUMBER</b> .....	<b>23</b>
<b>LOGS</b> .....	<b>24</b>
<b>TIME</b> .....	<b>24</b>
<b>HOLIDAY</b> .....	<b>25</b>
<b>SCHEDULE</b> .....	<b>25</b>
<b>GROUP TEXT</b> .....	<b>25</b>
<b>MINUTES LEFT (PX250HS ONLY)</b> .....	<b>26</b>
<b>LATE WORK</b> .....	<b>26</b>
<b>BYPASS</b> .....	<b>27</b>
<b>CHIME</b> .....	<b>27</b>
<b>SHUNT</b> .....	<b>28</b>
<b>PRINT TEXT</b> .....	<b>28</b>
<b>PRINT HOLS</b> .....	<b>28</b>
<b>IDENTIFY USER</b> .....	<b>28</b>
<b>COPY USER</b> .....	<b>29</b>
<b>COPY A/USER (PX ONLY)</b> .....	<b>29</b>
<b>CCT STATUS</b> .....	<b>29</b>
<b>ACCESS FEATURES (PX ONLY)</b> .....	<b>30</b>
<b>ADD A/USER</b> .....	<b>30</b>
<b>DELETE USER</b> .....	<b>31</b>
<b>DOOR UNLOCK</b> .....	<b>31</b>
<b>DOOR LOCKOUT</b> .....	<b>32</b>
<b>ACM TEXT</b> .....	<b>32</b>
<b>APPENDIX A – USER AUTHORITIES</b> .....	<b>33</b>
<b>APPENDIX B – EDITING TEXT</b> .....	<b>34</b>
<b>APPENDIX C - LOG MESSAGES</b> .....	<b>35</b>
<b>APPENDIX C – ACCESS LOG MESSAGES</b> .....	<b>38</b>
<b>APPENDIX E - MENU RESTRICTIONS</b> .....	<b>39</b>

---

**APPENDIX E - LOG ON MESSAGES..... 40**

**APPENDIX F – AUDIO COMMANDS ..... 41**

**APPENDIX G - SYSTEM DETAILS ..... 42**

    KEYPADS ..... 42

    SET GROUPS ..... 42

    CIRCUITS ..... 43

    USERS..... 44

**Introduction**

The PX Electronic Intruder Alarm System is designed to provide secure protection for the installation. The system comprises a main control panel, normally located out of sight in a secure area, and at least one keypad. The panel has a wide range of features, which are programmed by the engineer on installation, to suit the security requirements of the particular installation. Some of the features may be reprogrammed, edited, or viewed as required by an authorised user.

Feature	RX16i	QX32i	PX48i	PX80i	PX500	PX250 HS
Max. Panel Users	32	32	50	100	200	200
Max. Access Users	X	X	1000	1000	1000	1000
Areas	4	8	8	16	32	16
Set Groups	X	8	8	16	32	16
Sub systems	X	4	4	8	16	8
Max Keypads	4	8	8	16	32	16
Access Modules	X	X	32	32	32	32
Audio Modules	2	4	8	16	32	16
Radio Modules	2	2	4	8	16	8
Max. Transmitters	16	16	24	40	128	128
Tel Numbers	8	8	8	8	8	8
Schedules	2	4	32	32	32	32
Holidays	X	14	14	14	14	20
Event Log Size	250	500	1000	1000	1000	2000
Access Log Size	X	X	1000	1000	1000	1000

**Event Log**

The event log will record all events, for example, user log-on times and user numbers, keypad numbers, setting and unsetting times, alterations made to programmed settings, fault conditions, etc. When the event log is full, the oldest event will be automatically removed when the next event occurs. All log events are date and time stamped and may be viewed, or printed if a printer is fitted to the system.

**Areas & Set Groups**

For protection purposes, the premises may be divided into a number of areas. Individual areas may be grouped together into a setting group (Not RX16i) which provides the user with a convenient way of setting and unsetting more than one area at the same time. The installation company engineer will have configured your system for the appropriate number of areas and groups to comply with your specific security requirements. Where more than one group is incorporated in the system, a group can be configured by the installation engineer as a common group. A common group will automatically set if all other areas of the system are set and will automatically unset if any one of the other areas is unset. The RX16i variant does not include the set group feature. If using a RX16i then all references to set groups throughout this manual should be interpreted as areas.

**Circuits**

Each detector or sensor in the installation is allocated a unique circuit number. The installation engineer will have programmed each circuit to respond in a certain way when the circuit is activated, when the area is set and unset. The way in which the circuit is programmed to respond will depend on the type of circuit and its location and purpose. If a circuit is faulty, the alarm response may be turned off by an authorised user. This process is referred to as bypassing.

**User, Set group and Circuit Identification**

Each user, set group, circuit, concentrator and access control module can be programmed with a text description.

**User Codes**

Each user of the system is identified by a unique code. This code can be a PIN code, a magnetic swipe card, proximity card or fob. A card or fob can only be used on a keypad variant with a proximity interface (internal or external). The default PIN code for user 2 is **0202**. Throughout this manual user codes are only referred to as codes.

**Operator Controls and Displays**

**System Keypads**

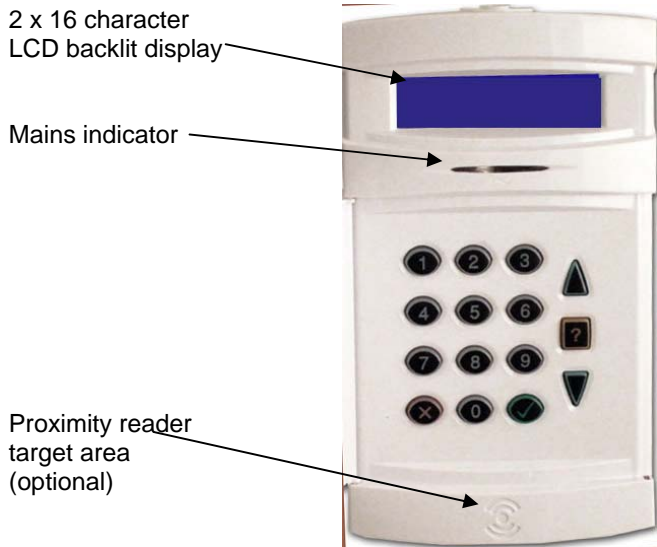

The operator keypad unit incorporates a backlit liquid crystal display (LCD) comprising 2 lines of 16 characters, and a backlit keypad to gain access to the system and to perform all authorised user functions. The backlighting will be turned on during the entry time, during code entry and while a user is logged on. It may also be turned on using any button except ✓ and x and turned off using the ✓ or x buttons. Keypads may be fitted with an internal proximity reader. The keypad incorporates a mains power indicator. This indicator will flash if the system is operating on standby battery power.

**Mini Keypad**

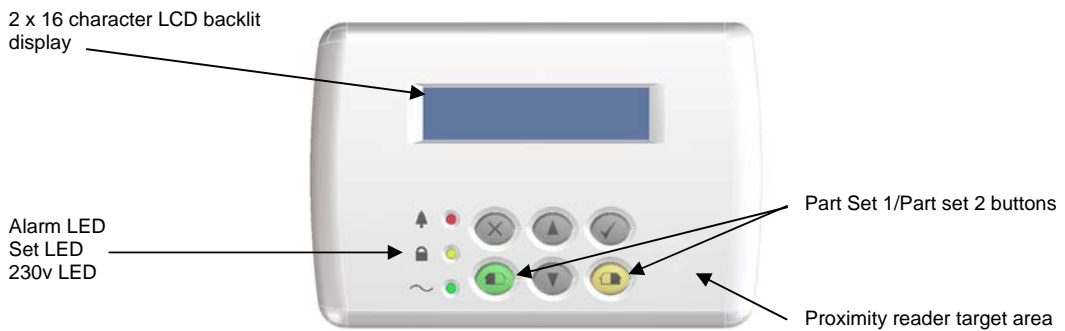

**Cards/Fobs**

A user PIN code can be replaced by a card or fob if the keypad is fitted with the optional internal or external reader. All Guardall proximity cards and fobs are manufactured with a unique code and duplicate cards or fobs cannot be obtained. Spare or replacement cards or fobs can be obtained from the installation company.

**Dual User Code Operation**

Where a higher level of security is required a keypad may have been programmed to require two user codes to be entered before logging a user on to the system. Both user codes must be authorised and are logged by the system. The authority of the second user code entered is used by the system. The second user code must be entered within 15 seconds of the first user code.

**User Card+PIN Operation**

Each user can be programmed with both a PIN and a card. If the user Card+PIN option is programmed then both codes have to be entered before the user can log on to a keypad.

**Using the System**

The LCD keypad will normally display the time, date and company name. If a valid code is entered the user menu will normally be displayed. The default manager code is 0202<sup>1</sup>. Enter this code followed by the ✓ button to log on.

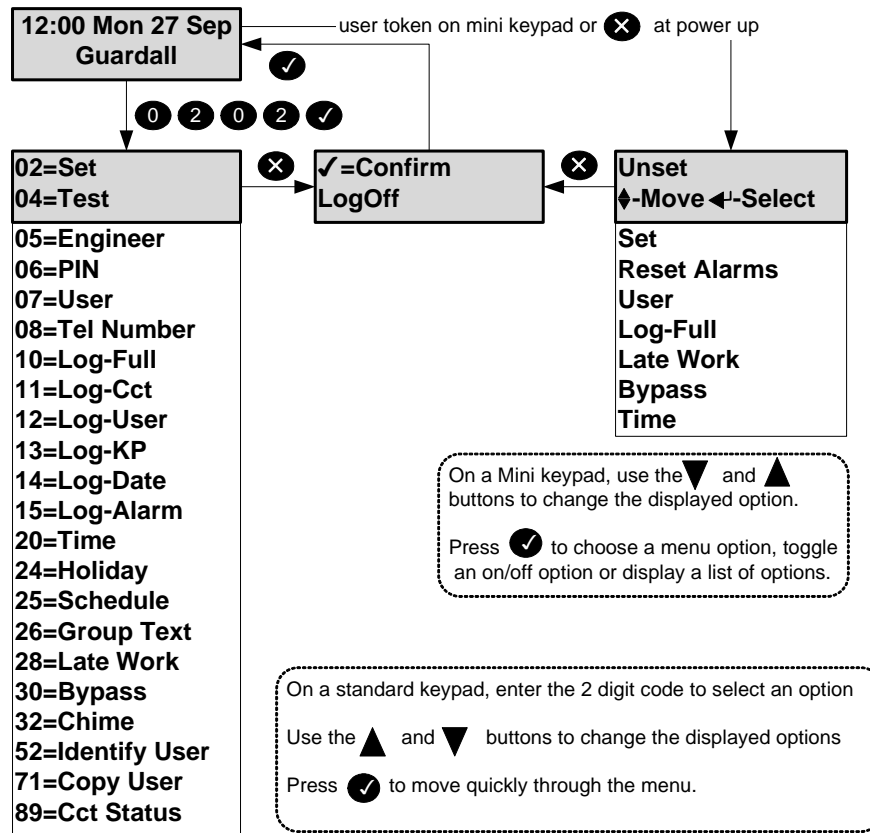

The menu options shown are for a manager user on a system without access control. The actual menu options available to a user will depend on the user authority, the system configuration and the current system status. Refer to appendix A for details. Only 2 options are visible on the display but any available option can be selected by entering the 2-digit code without viewing the actual option number. Each menu option is discussed in detail in this manual. If no option is selected the user will be automatically logged off after 2 minutes. If a chosen option is not available a reason will be displayed. Refer to appendix D for details. Information about the system may be displayed when logging on. Refer to appendix E for details.

<sup>1</sup> It is recommended that the manager code is changed from the default as soon as possible.

**Easy Set**

If your system is programmed with the easy set option then all PIN codes are 4 digits long and PIN codes can be entered without confirming with the ✓ button. A card or fob may still be used in place of a PIN when easy set is programmed.

**Help**

When the main user menu is on display press the help button (?) to display information about the system. There are 3 options.

Option	Description
Assist	Select to connect to a remote service operator. Your alarm company may not support this feature.
Contract	The customer contract number is a 6-digit number programmed by the installation engineer that uniquely identifies your system.
Product Info	The product info option displays the control panel order code and firmware version number and, if fitted the Dialler version number.

An authorised user can change some of the system parameters. When changing an item the help button can be used to display the allowed values.

**Remote Assist**

Before using the remote assist option you must obtain a number from your alarm company. When you need to use the remote service, you will be prompted to enter this number, and the panel will dial the alarm company. The alarm company will then be able to check the condition of your system and identify and resolve problems.

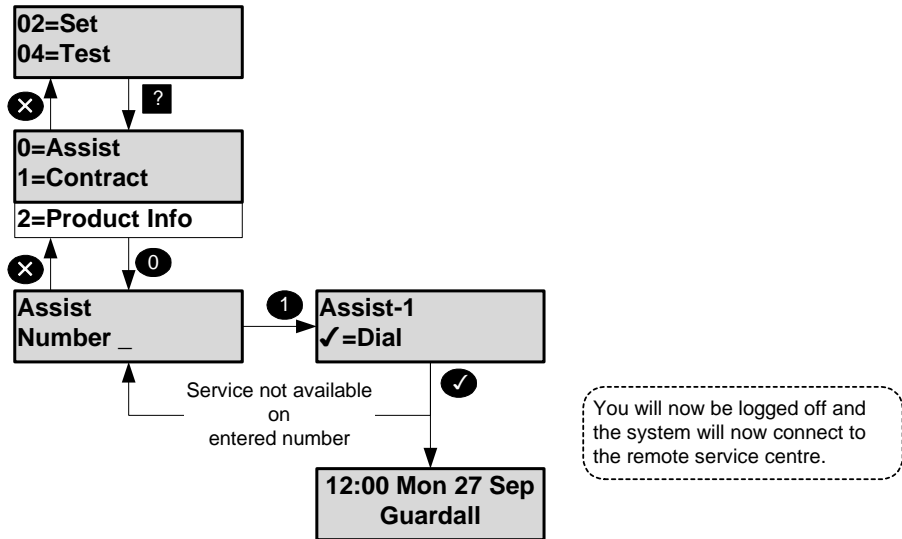

**Incorrect Codes**

If Easy Set is not programmed and an incorrect user code is entered, the incorrect code message will be displayed for a few seconds or until another key is pressed. The installation engineer will have programmed a limit on the number of incorrect code attempts that can be made. If more than the programmed number of code attempts are made to enter a valid user code, the keypad will be locked out and the display will show **Out of Service** for a period of 5 minutes. Any attempt to enter a user code during the locked out period will extend the period by another 5 minutes.

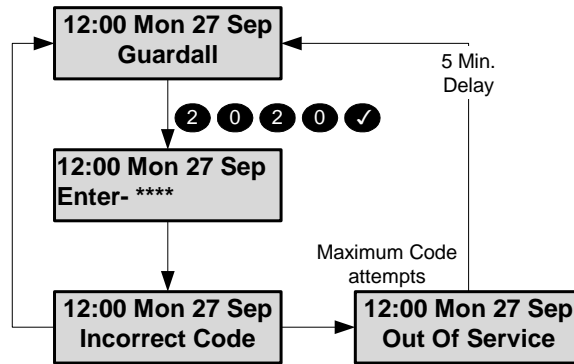

**Set** **Code-02**

The system can be partitioned into a number of parts called set groups, each of which can be individually set. The programmed user authority level must allow setting and the programmed user area access will determine which set groups are available to a user.

Setting can be started by:

1. A user request on a keypad
2. A user activating a keyswitch or radio Keyfob
3. Automatically by a timer schedule
4. Remotely from a PC using the Guardall GuardStation software
5. A user request on an ACM Proximity Reader.

Setting modes include:



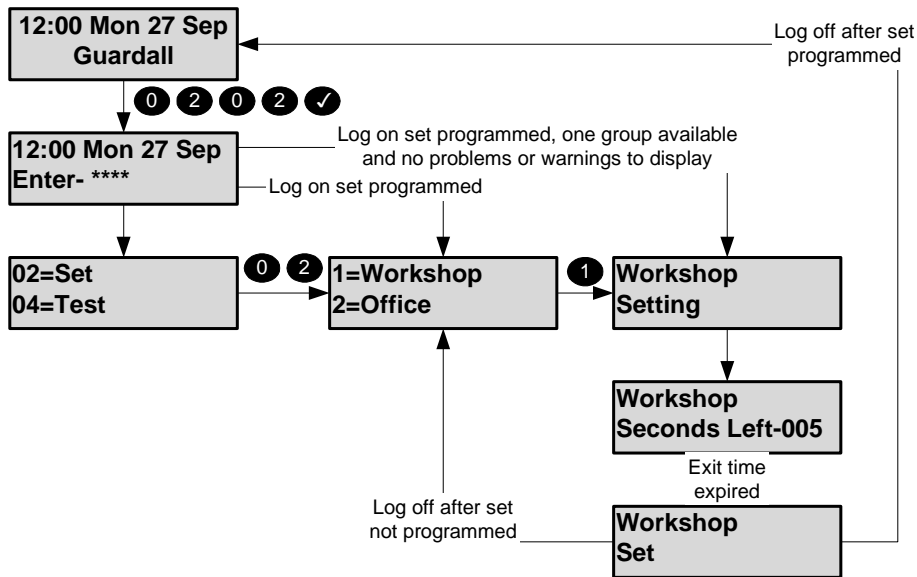

1. Instant, where setting is completed immediately
2. Timed, where setting is completed at the end of the programmed exit time
3. Exit point, where setting is completed by opening and closing the final exit circuit
4. Push button, where setting is completed by pushing the external PB circuits after opening and closing the final exit circuit

Your installation engineer should advise which of the above options have been programmed on your system.

**Setting from a keypad**



**Setting with a Mini Keypad**

 The mini keypad has two quick set buttons. The actual areas or groups controlled by the green and yellow buttons will depend on how the system has been programmed by the installer. The green button  will set/unset the first programmed area or set group and the yellow button  will set/unset the second programmed area or set group. Pressing and holding both  and  will set the first and second group or area.

### Keyswitch/Radio Keyfob Setting

As an alternative to setting and unsetting from a keypad, your system may be fitted with an optional keyswitch, which permits setting and unsetting of a group by operating a keyswitch. The keyswitch may be configured for any set mode. If your system is fitted with a radio interface then a radio Keyfob may be programmed for setting.

### Automatic Setting

The system may have been programmed by the installation engineer to automatically set all or parts of the system according to a pre-programmed schedule. The schedule will have been programmed to take into account the normal closing time, non-working days and holidays. The schedule may be configured for any set mode.

### Aborting The Setting Procedure

The setting procedure can be aborted at any time during the exit time by pressing **X** on the keypad that was used to start setting, logging on to any other keypad, turning a keyswitch to the unset position or an appropriate radio Keyfob.

### Setting with Warnings



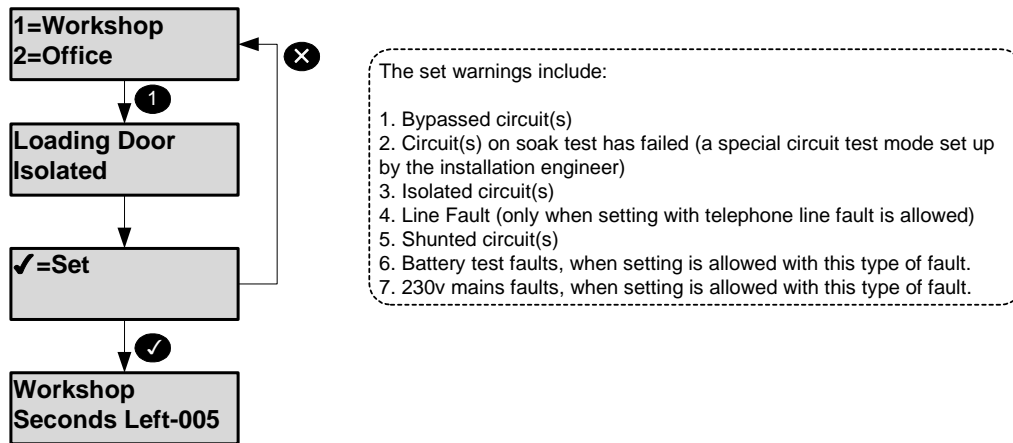

The system will automatically display any conditions that the user should be aware of before setting the system. These conditions are described as set warnings and do not prohibit the user from setting the system in the normal way.



### Easy Set

If easy set mode 1 is programmed then the system will start to part set when you log on. During the part set exit time, if the exit door circuit is opened and closed, the system will full set. Pressing the **X** key during the setting time will cancel setting. If easy set mode 2 is programmed then the system can be set without logging on to a keypad. Up to 8 parts can be set in this way (depends on the control panel type). For example to set part 1 of your system from 1 + ✓. The system can be set by entering 0 + ✓.

If using a mini keypad then the house symbol buttons can be used to set.

-  + ✓ = set first group or area.
-  + ✓ = set second group or area.
-  and  + ✓ = set first and second group or area.

**Setting Restrictions**

1. The selected group is programmed with a set level and a lower level set group(s) has not been set.
2. If a user attempts to set a high level set group when a lower level is not set then a warning message will be displayed.

In a PX250HS, there are several additional conditions that apply when setting.

1. The keypad may be programmed to disable setting
2. The selected group may be programmed for dual user set

**Setting Faults**

If the group cannot set a message will be displayed. This can occur at the start of setting or at the end of the exit time depending on how your system is set up and when the fault occurs. If a fault occurs during the exit time the exit tone will change to a warning tone. The external sounder may also have been programmed by the installation engineer to activate in the event of a failure to set.

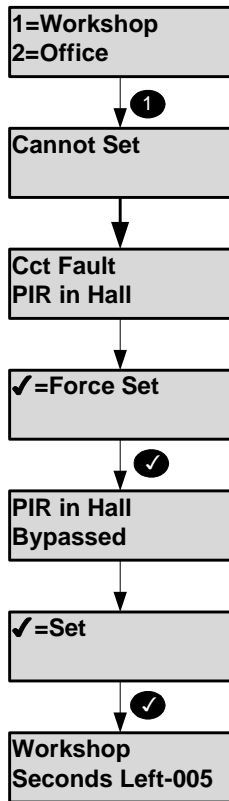

After the setting fault(s) is displayed the force set option may be presented (if programmed by the installation engineer). The force set option will attempt to automatically bypass all faults. The circuit(s) with the fault must be programmed by the engineer to allow bypass.

**Dual Set (PX250HS Only)**

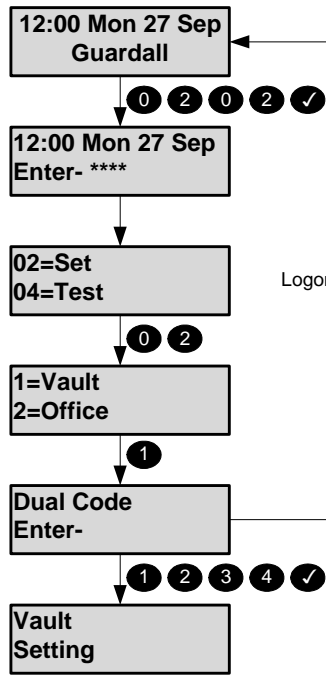

In the example the vault area is programmed for dual user set. The first user code is 0202 and the second user code is 1234. Both users must have the authority to set the vault area. Both user actions are logged.

**Unset** **Code-01**

The system will have been partitioned by the installation engineer into a number of set groups. The user authority will determine the choice of groups, which can be unset. There are several methods of unsetting available to the user, which are discussed in the following section.

Unsetting can be started by:

1. A user request on a keypad
2. A user activating a keyswitch or radio Keyfob
3. Automatically by a timer schedule
4. Remotely from a PC using the Guardall GuardStation software
5. A user request on an ACM Proximity Reader.

Your installation engineer should advise which of the above options have been programmed on your system.

**Unsetting Methods**

If a set group incorporates an entry route in the unsetting procedure then opening a final entry door to the area will start a pre-programmed entry timer. The user must proceed directly to the keypad or keyswitch via a pre-determined entry route and unset the group as described. If the group is not unset before the entry time has expired a warning period of 30 seconds will be given. This is to warn the user that an alarm condition will occur if the group is not unset by the end of the warning period. If the group is not unset by the time that the total entry time and warning time has expired, an alarm condition will be initiated. To comply with the requirements of DD243 (2002), during the entry time, all alarms in the unsetting area(s) are ignored.

**Unsetting from a keypad**

Your installer may have set up your system to allow automatic unset when your user code is entered. The diagram shows all 3 possible unset scenarios when a user logs on to a keypad when area(s) are set.

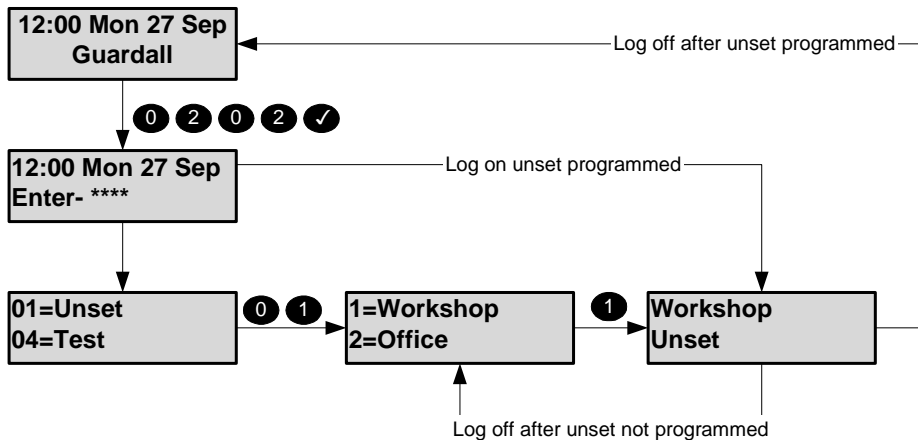

**Unsetting with Keyswitch or Radio Keyfob**

To unset an area from a keyswitch, turn the keyswitch to the unset position. The area under the control of the keyswitch will immediately unset. . If your system is fitted with a radio interface then a radio Keyfob may be programmed for setting.

### Automatic Unsetting

The system may have been programmed by the installation engineer to automatically unset all or parts of the system according to a pre-programmed schedule. The schedule will have been programmed to take into account the normal opening time, non-working days and holidays.

### Unsetting Warnings

When unsetting from a keypad, the user is informed on the display of any warnings, e.g. circuits isolated or on soak. The warning display will appear for approximately 4 seconds during the unsetting procedure. If more than one warning exists, the display will automatically scroll through the list of warnings.

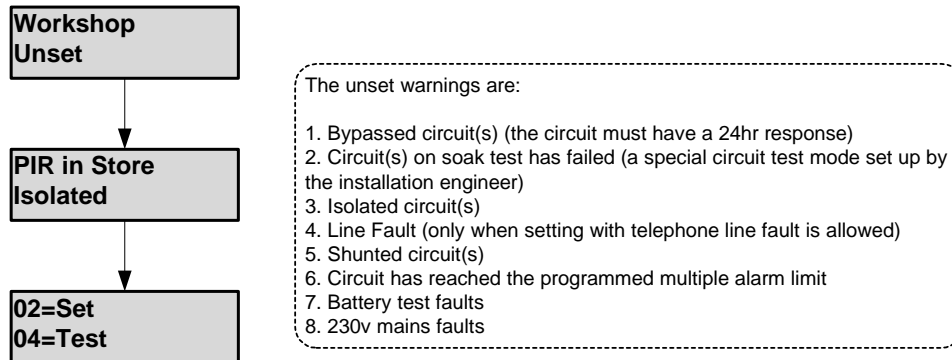

### Unsetting Restrictions

The selected group is programmed with a set level and a higher level set group(s) has not been unset. If a user attempts to unset a high level set group when a lower level is set then a warning message will be displayed.

In a PX250HS, there are several additional conditions that apply when unsetting.

1. The keypad must be programmed by the engineer to allow unset
2. The selected group may be programmed for dual user unset
3. An open/close schedule may be programmed for the selected group and the time is after the programmed close time. This condition may be ignored following an alarm in one of the set group areas if the set group is programmed with an alarm unset time. In this case, after unsetting, the set group will automatically set after the programmed Alarm Unset period.
4. The selected group may be programmed with an Unset Delay time and set group will only unset at the end of the programmed unset delay period. A message will be displayed during this time and the user unset request will be logged.
5. If a group is manually set before the scheduled set time then it may be unset up to the number of programmed Early Set minutes after the time the group was set.
6. The schedule unset option does not apply.

**Unset Delay (PX250HS Only)**

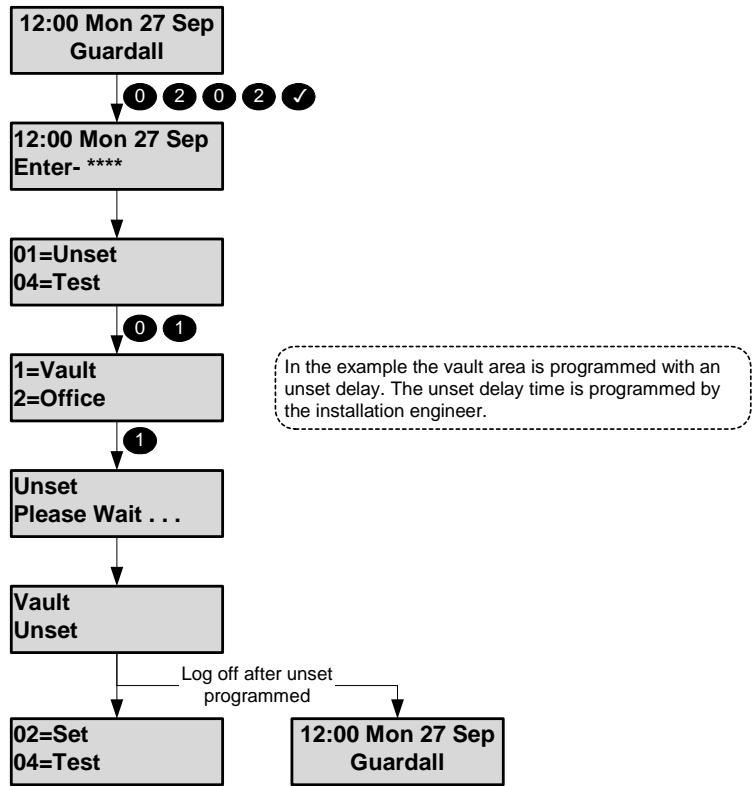

**Dual Unset (PX250HS Only)**

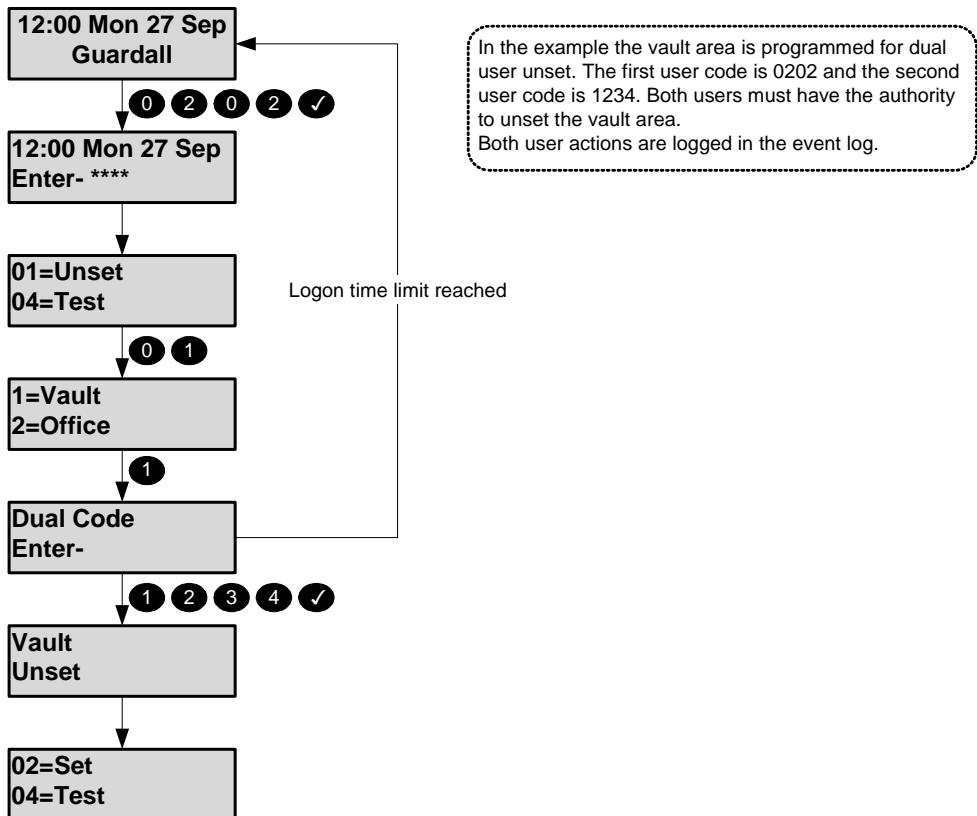

**Reset** **Code-03**

The resetting method programmed by the alarm company engineer for each area and the system will depend on the particular security requirements of the area or system. There are 3 types of reset:

1. Customer reset, where the customer can reset any alarm
2. Engineer reset, where the alarm company engineer must reset all alarms
3. Managed reset, where the customer can reset an alarm after reporting the event to the alarm company

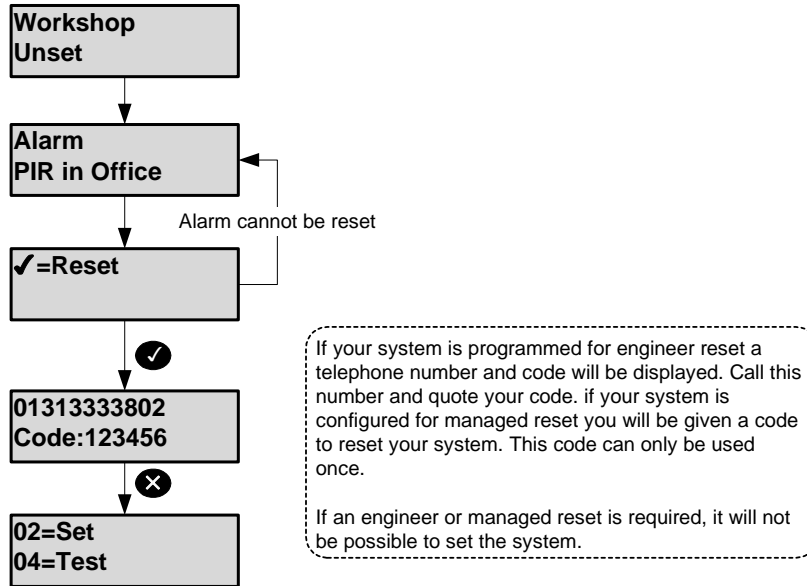

**Managed Reset**

If the system is programmed for managed reset and an engineer reset is required contact the alarm installation company. You will be issued with a special 6-digit PIN code. This PIN code can be used only once to reset the system. Logon to the keypad with this PIN code to clear the engineer reset condition.

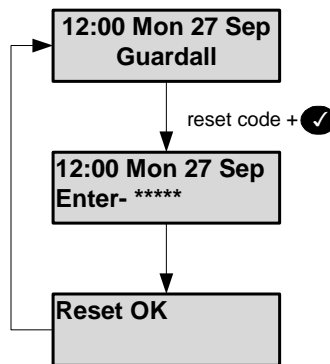

**Test** **Code-04**

Each area of the system can be tested individually or all areas can be tested at the same time. The test time is limited to 1 hour. If the user does not end the test by the end of the test time then the panel will exit test mode automatically.

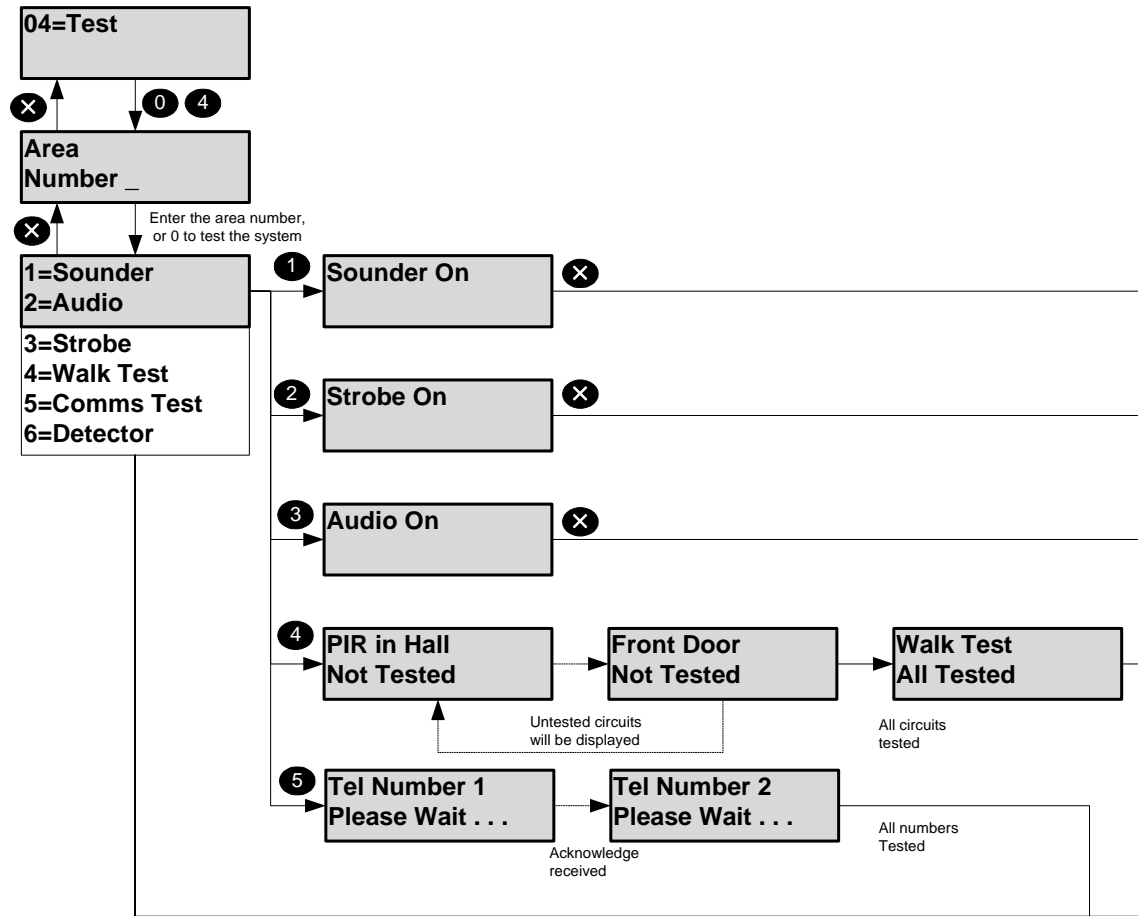

The panel records all activations from sensors during the unset period. When walk test is selected the panel will display all circuits which have not alarmed since the panel was last unset. If all circuits are to be tested then select walk test, then press the X button and select walk test a second time. When the panel exits walk test mode, either manually or automatically at the end of the test time then:

1. Any fire sensor still in alarm will give a normal alarm response.
2. Circuits with a 24-hour response, which are still in alarm, will be temporarily bypassed.
3. A warning will be displayed if any PA sensor is still in alarm.

If the comms test is selected then the panel will make a test call to all telephone numbers that have been programmed for test by the installation engineer.

**Engineer** **Code-05**

The Eng option will only be available if the system is configured for user authorised engineer access. This option applies to both local and remote engineer access. When the Eng option is selected the system will prompt for the engineer PIN code to be entered.

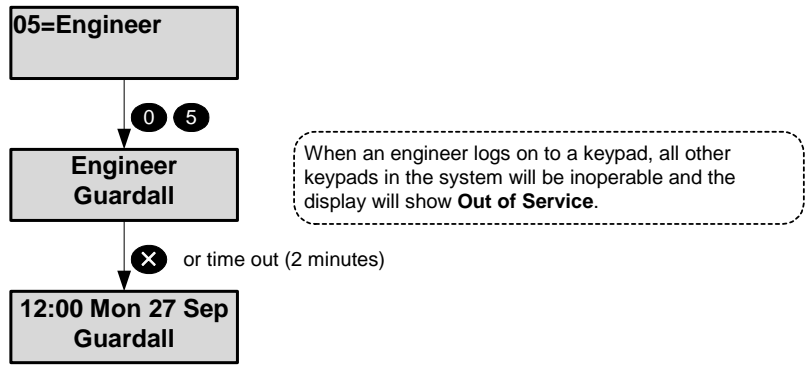

Once logged on the engineer working time is limited to 8 hours.

**PIN** **Code-06**

All users on the system are identified by a 4, 5 or 6-digit PIN code. To change user PIN code, log on to the keypad using your current PIN code and choose the PIN option. Then follow the display prompts. All user PIN code changes are recorded in the system event log. If the PIN code option is not available this means that the system has been programmed to prevent you from changing your user PIN code, and a new PIN code must be allocated by the security system manager. In the example shown the user changes code to 1234.

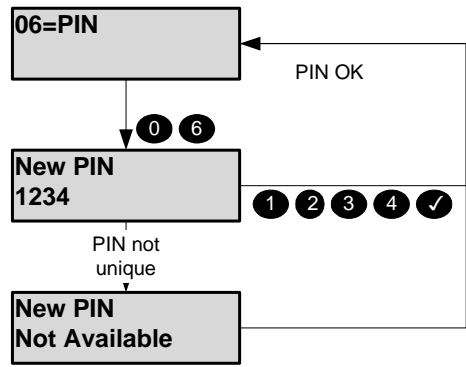

If another user on the system already uses the chosen PIN code then that user will be alerted when next logging on to the system. The user whose PIN is known must change PIN code to avoid seeing the warning message on every log on.

**User** **Code-07**

Any master user can change the name, user code and authority for any user except the engineer. To modify a user's details enter the user number in the range 2-max users. In the programming example user 3 is used.

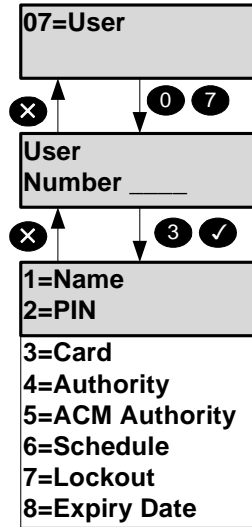

The user 2 configuration may only be changed by user 1 or user 2. Access system users can be added quickly using the “Add User” menu option (50), rather than programming them individually.

**User Menu** **Code-1**

When the name option is selected the current user descriptor will be displayed and can be edited. Refer to appendix B for details. User names can be up to 10 characters long.

**User Menu** **Code-2**

For details of changing a code refer to the main menu code change option. The default user codes are shown in the table. The maximum PIN code length is 6 digits.

Default Codes	
User Number	PIN
2	0202
3-last user	Off

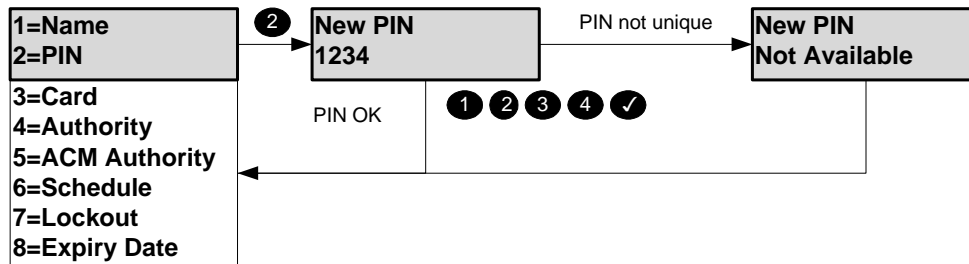

<b>User Menu</b>	<b>Card</b>	<b>Code-3</b>
------------------	-------------	---------------

The procedure for adding a card is similar to adding a new PIN. Present the new card to reader when prompted to do so. Alternatively, if the card number is known, it can be entered on the keypad. The maximum number of card digits, excluding the optional site ID, is 8 digits

<b>User Menu</b>	<b>Authority</b>	<b>Code-4</b>
------------------	------------------	---------------

Users can be programmed with a number of options including authority level, group access and timed access. The available menu options are dependent on the programmed user authority. Refer to the menus options section for details of the menu options available to each authority level

Option	Range	Description
Code Change	On/Off	Some user types are allowed by default to change their own code (refer to authority table). This feature can be disabled for any user without manager authority.
LogOnSet	On/Off	If this option is on, the system will show a list of set groups that are available to set. If only one set group is available setting will start automatically.
LogOn/Unset	On/Off	If this option is on then the authorised set groups, which are set will be unset when the user logs on.
Shunt	On/Off	If this option is on the user has access to the shunt menu option (33).
Card+PIN	On/Off	If the user is configured with the Card+PIN option then BOTH the PIN code and the card must be used to log onto a keypad. The PIN code and card may be used in any order. This option does not apply when using an access module. If Card+PIN is off then a user may log onto a keypad using EITHER a PIN code or card.
Set group 1, max	On/Off	A user can be programmed any combination of set groups.

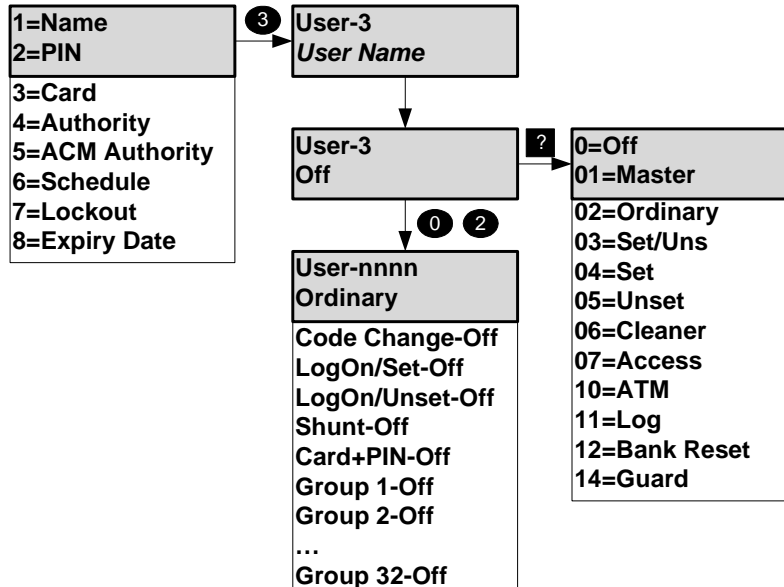

<b>User Menu</b>	<b>ACM Authority (PX Only)</b>	<b>Code-5</b>
------------------	--------------------------------	---------------

This option will only be available if at least one ACM is fitted to the system.

Option	Range	Description
Enable	On/Off	If this option is off no further user ACM options will be displayed in this menu.
Level	Normal, Visitor, Escort or Supervisor	The access authority of each user can be programmed.
ACM 1 - maximum	On/Off	A user can be authorised for access through any combination of ACM doors.
Challenged	On/Off	If a user is programmed as challenged then the ACM door release and open times will be automatically doubled for the user.

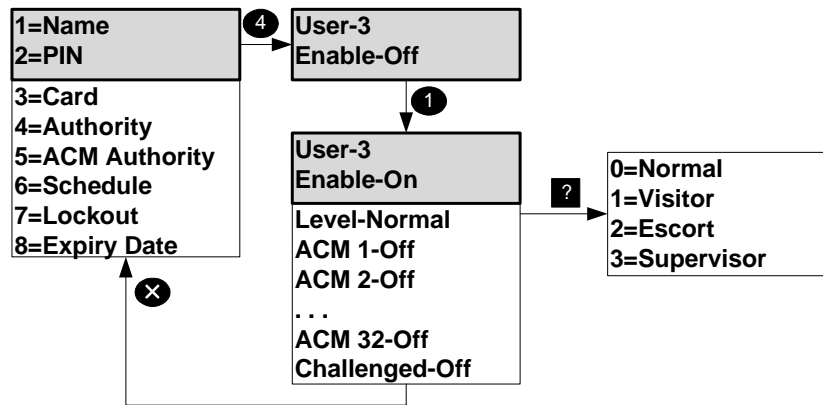

<b>ACM Authority</b>	<b>Level</b>	<b>Access level Help Menu</b>
----------------------	--------------	-------------------------------

User access right will depend on the programmed user level and the programmed access door mode (programmed by the installation engineer). There are no restrictions on exit.

User Mode	User Access Restrictions			
	Door Mode			
	Normal	Dual	Escort	Supervisor
Normal	✓	1	✓	X
Visitor	✓	X	2	X
Escort	✓	1	4	X
Supervisor	✓ (3)	✓ (3)	✓ (3)	✓ (3)

Notes:

1. Dual mode access requires 2 users with either Normal, Escort or Supervisor authority.
2. A visitor user may only gain access within 10 seconds of an escort user presenting their token.
3. A supervisor user can access a door with lockout enabled.
4. An escort user can gain access by presenting their token twice within 10 seconds.

<b>User Menu</b>	<b>Schedule</b>	<b>Code-6</b>
------------------	-----------------	---------------

A user can be programmed with a schedule to control access times. Program 00 to allow 24hr access. The schedules can be programmed using option 25.

**User Menu** **Lockout (PX Only)** **Code-7**

This option will only be available if at least one ACM is fitted to the system. If the lockout option is on for a user then the user code will be ignored until the lockout is turned off.

**User Menu** **Expiry Date (PX Only)** **Code-8**

Expiry dates can be programmed for all users (panel and access users).

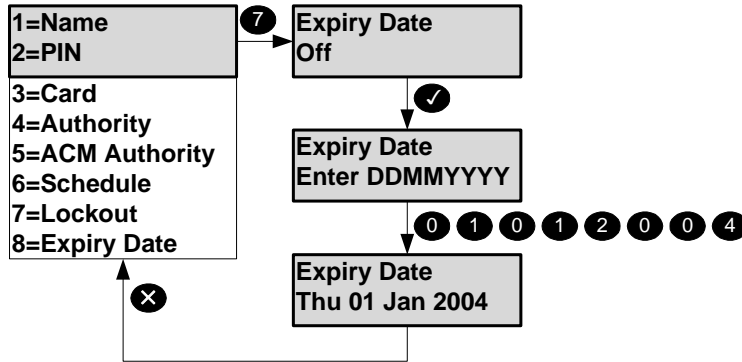

To delete an expiry date, enter the day and month of 0000 and the current year. The user authority and codes will be removed from the system at midnight on the expiry date.

**Tel Number** **Code-08**

An authorised user can change any telephone number that has been programmed to use the speech format, home beep or SMS formats. The available formats will depend on the system hardware options. A telephone number of up to 16 digits can be programmed. This number can include pause digits. Pause digits can be entered using the ↓ button. This will be displayed as a “,” character. Each pause digit represents a 1 second delay. Pauses may be required if you are signalling via a PABX or if the call is routed through an old exchange. Enter a single zero to turn off a telephone number. Press **X** to delete a single digit.

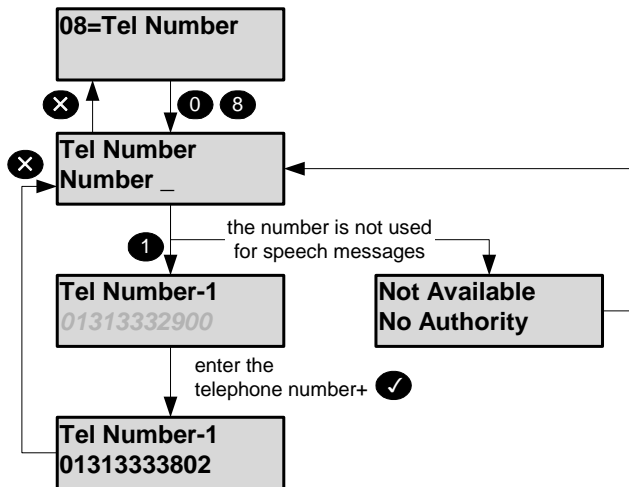

An alarm in the home beep format is transmitted as a series of DTMF tones. For example if channel 3 was active the transmitted message would be:

3 3 3 < 2s delay> 3 3 3 < 2s delay > 3 3 3 < 2s delay> 3 3 3 < 2s delay > 3 3 3

Where ‘3’ is the tone pair for DTMF digit 3. The channel information is repeated a maximum of 5 times during a call.

## Logs

The panel logs all events that occur in the system. All events stored in the event log are numbered in the range 0-65535 (the event index). The event index will be reset to 0 when more than 65535 events have been recorded. There are 2 logs, the security log and, if an ACM(s) is fitted, an access log. Each log can be viewed in full or filtered form on a keypad and printed if a printer is connected to the system. Options 16-18 will only be displayed if there is at least one ACM on the system. Only events for authorised areas and access doors will be displayed or printed.

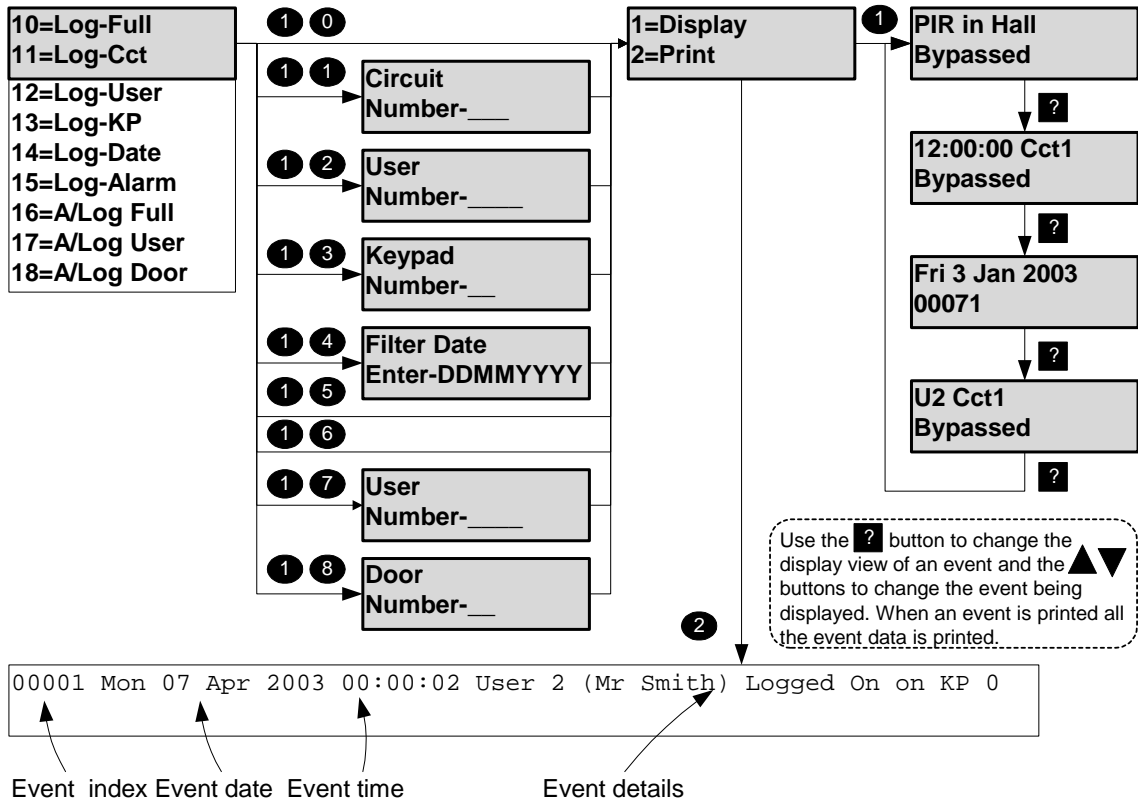

Refer to the appendix C for details of all log messages.

## Time Code-20

Some users have the authority to change the time by up to 75 minutes from the time set by the engineer if the user clock edit option is programmed. Time changes are recorded in the event log.

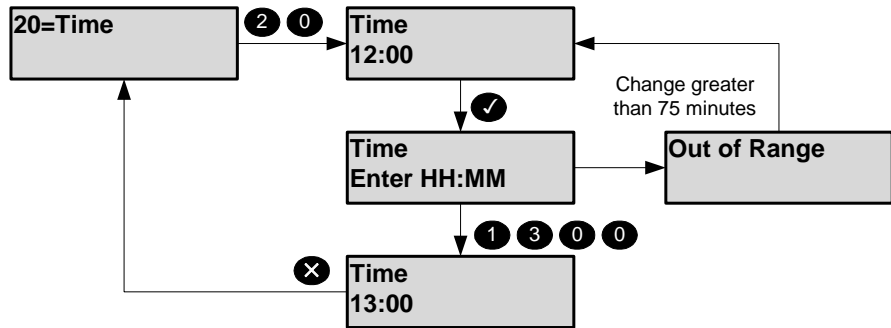

**Holiday** **Code-24**

The programmed holidays are used in conjunction with the programmable schedules. The holiday date format is day and month only. No year is entered therefore the entered date will remain programmed as a holiday for all years, or until it is removed from the holiday schedule. It is not possible to program a holiday period that starts in December and ends in January. To achieve this 2 holiday periods must be programmed.

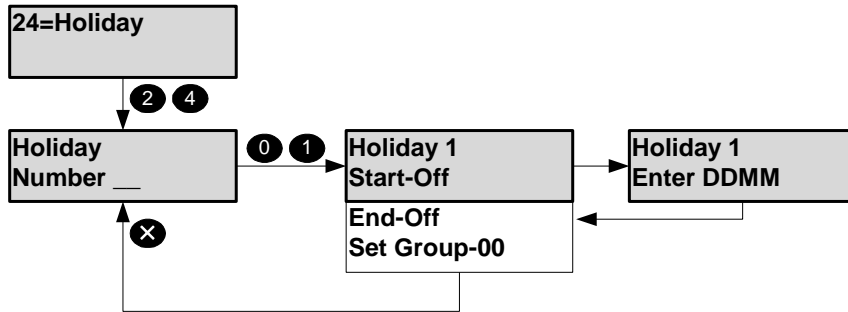

To disable a holiday enter a date of 00:00. The start and end dates must be in chronological order. Holidays may be optionally programmed to apply to individual set groups

**Schedule** **Code-25**

A schedule consists of 4 times for each day of the week and 4 times for days which are holidays. A schedule can be used to:

1. Auto set and unset parts of the system
2. Control outputs
3. Enable/disable keypads
4. Enable/disable user access
5. Lock/unlock access doors

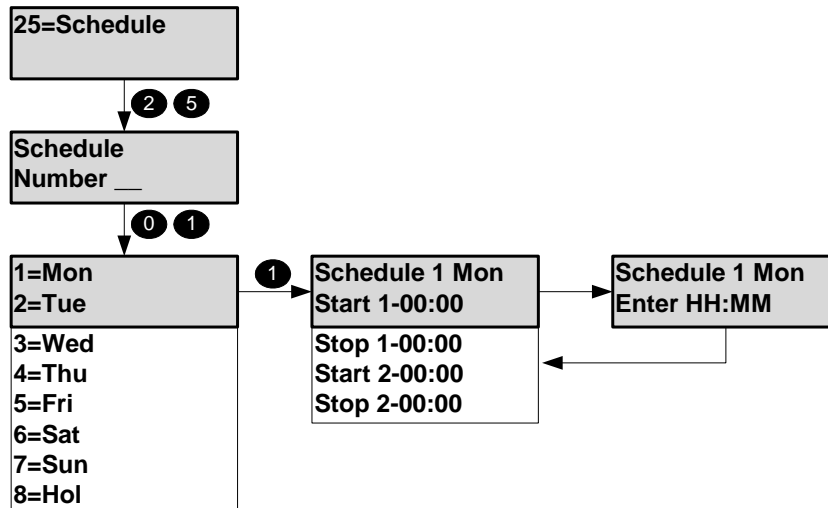

**Group Text** **Code-26**

A descriptor of up to 10 characters may be entered for each set group. Refer to appendix B for details of how to change a descriptor.

**Minutes Left (PX250HS Only) Code-27**

This option is only available to an ATM user. When an ATM user code and a non-zero ATM delay period is programmed then a delay prompt will be displayed when the ATM user code is first entered.

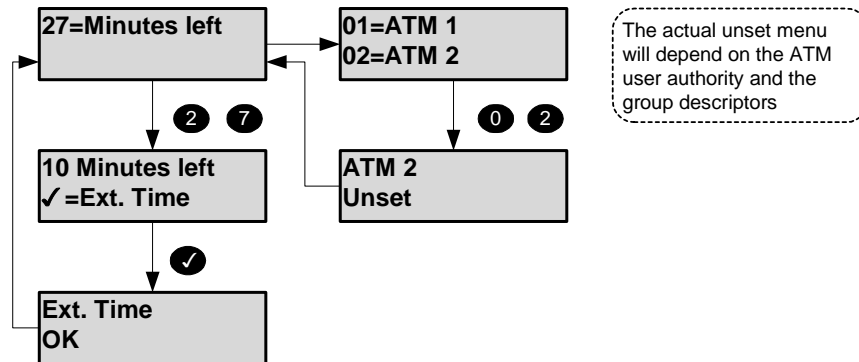

If the working time is less than 10 minutes, and an extension time is programmed, then the ATM user may extend the working time. If the programmed ATM working time is more than 10 minutes then a warning will be given when the ATM user has 10 minutes working time left and the extend time prompt will be displayed automatically. Requests to extend the time will be logged. **At the end of the working time the ATM user will be automatically logged off and areas that were unset by the ATM user will be automatically set. If an ATM user logs off without setting the ATM user authorised areas will be automatically set.**

**Late Work Code-28**

The late working option will only be displayed if at least one set group is programmed with a schedule and late working has not been already selected. When the late working option is selected a list of all available set groups will be displayed. The late work time can be any time, including times after midnight. All late working actions are logged.

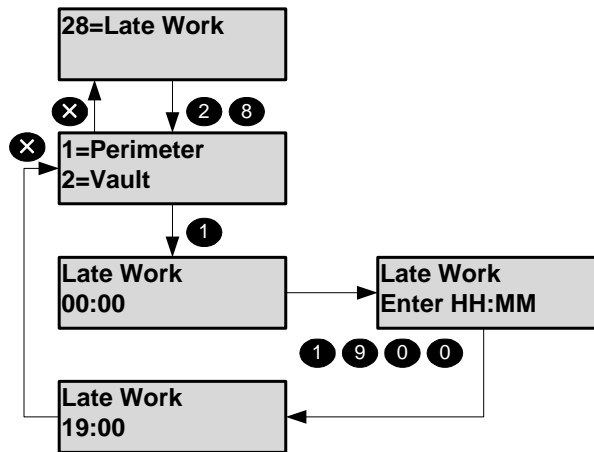

**Bypass** **Code-30**

The bypass option will only be available if a circuit(s) has been programmed as bypassable by the installation engineer. The bypass circuit option allows the user to bypass a circuit that is in a fault condition. When bypassed the alarm condition of a circuit is ignored. When a circuit is bypassed it is ignored until the bypass is automatically removed when the circuit is next unset or until a user removes the bypass. All bypass actions are stored in the event log. A bypass limit will have been programmed by the installation engineer to limit the number of circuits that can be bypassed at any one time. The system will display an error message if you try to exceed this limit.

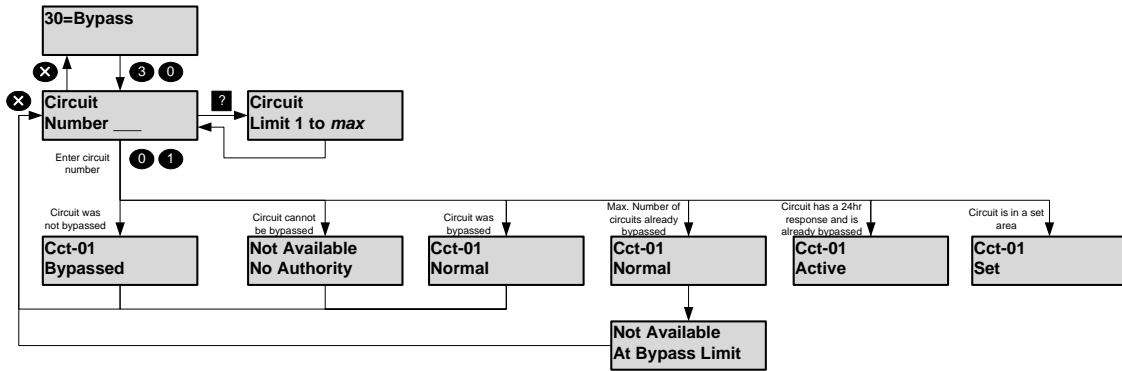

**Chime** **Code-32**

Certain circuit types can be selected as chime circuits when unset. To select the chime function for a circuit, enter the circuit number. In the example chime is turned on for circuit 1.

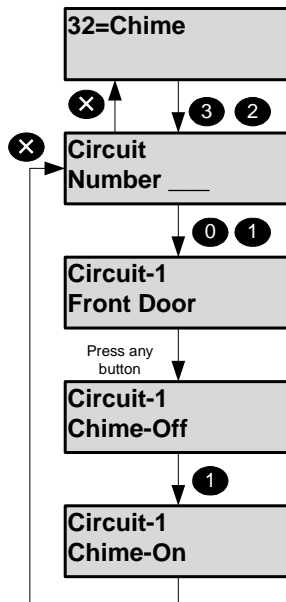

**Shunt Code-33**

A manager or ordinary user can be programmed with the shunt option. The shunt option will only be displayed if there are shuntable circuits in the user authorised areas. Shunted circuits may be viewed at any time using option 89 (Cct Status). All shunt actions are logged.

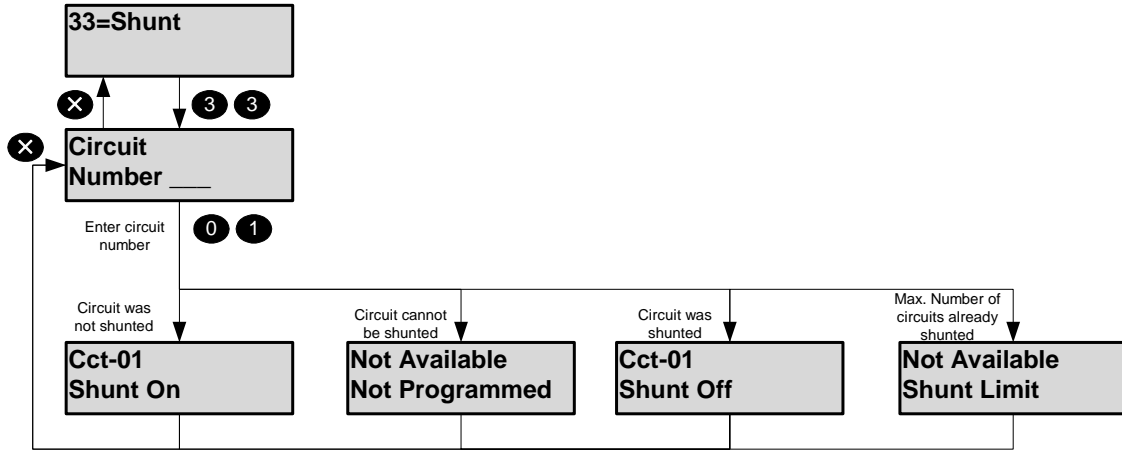

**Print Text Code-40**

This option will only be available if a printer is connected to the system. The print text option will print all text descriptors.

**Print Hols. Code-42**

This option will only be available if a printer is connected to the system. The print holiday option will print all holiday periods.

**Identify User Code-52**

This option allows a user to be identified by presenting the card/fob.

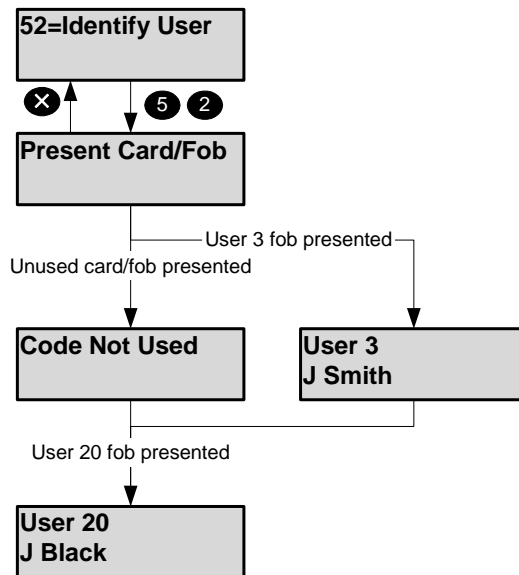

**Copy User** **Code-71**

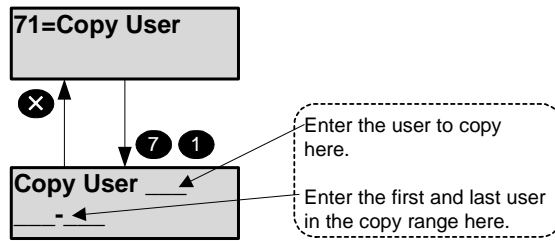

To copy a single user, enter the same user number as the first and last.

**Copy A/User (PX Only)** **Code-73**

This option will only be available if at least one ACM is fitted to the system.

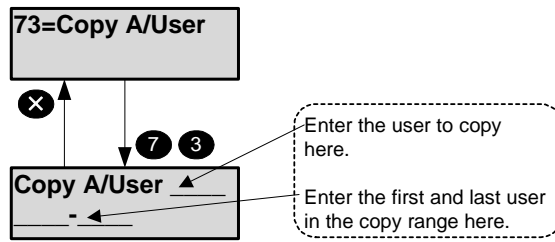

To copy a single user, enter the same user number as the first and last.

**Cct Status** **Code-89**

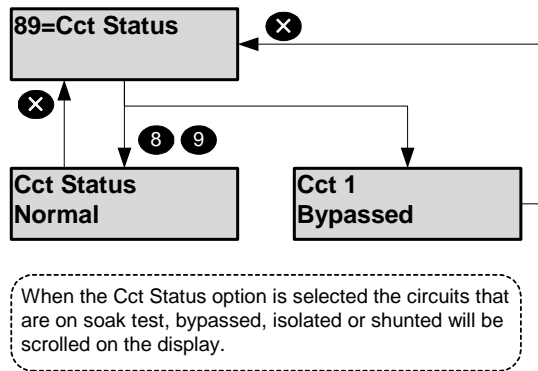

**Access Features (PX Only)**

The number of ACMs that can be connected depends on the panel variant:

The table shows the access features across the panel range.

Feature	PX18	PX34	PX80	PX500
ACMs	2	4	16	32
Panel Users	20	40	100	200
Access Users	100	100	1000	1000
User expiry dates	✓	✓	✓	✓
Challenged user option	✓	✓	✓	✓
User lock out from keypad	✓	✓	✓	✓
ACM Door lock/unlock from keypad	✓	✓	✓	✓
Programmable unlock time	✓	✓	✓	✓
Programmable Aux. relay time	✓	✓	✓	✓
Anti pass back	✓	✓	✓	✓
Access log events	1000	1000	1000	1000
Access log real time print	✓	✓	✓	✓
Set & unset	✓	✓	✓	✓

Note: The panel users must be the first users in the system. For example on the PX 500 users 2-200 may be access or panel users, users 201-1000 can only be access users and user 1 is always the engineer. The PX access control system can be configured through a security system keypad or a PC running GuardStation™ Access. Guardall PX proximity cards or fobs may only be introduced to the system through a PX keypad with an integrated proximity reader.

**Add A/User Code-50**

This option will only be available if at least one ACM is fitted to the system.

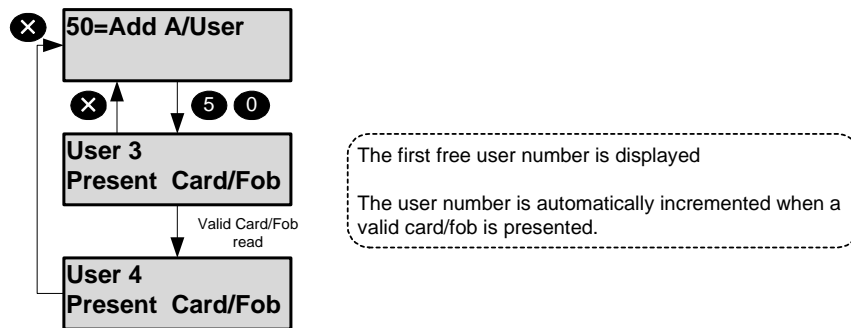

The user authority is automatically set to Access for all ACM doors and the user text descriptor will be defaulted. If required the user authority can be changed using the edit user option.

**Delete User** **Code-51**

This option will only be available if at least one ACM is fitted to the system. In the example shown user 3 is deleted from the system.

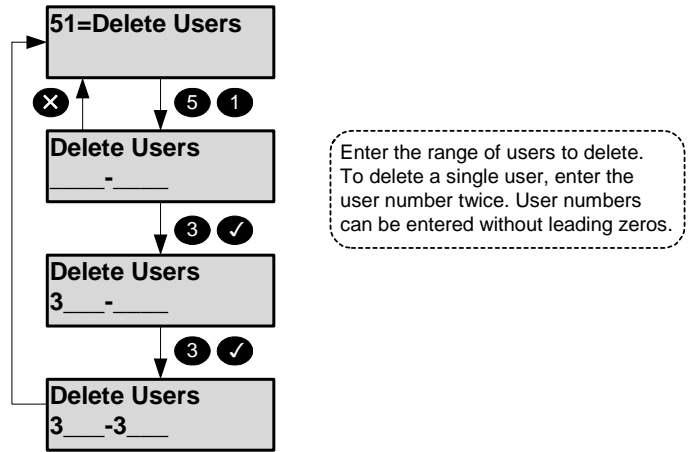

**Door Unlock** **Code-53**

This option will only be available if at least one ACM is fitted to the system. An ACM door can be manually locked/unlocked from a keypad. An optional unlock time of up to 255 minutes can be programmed. If a time of zero is programmed the door will remain unlocked until the unlock option is turned off. While a door is locked it can still be opened by presenting a valid user card.

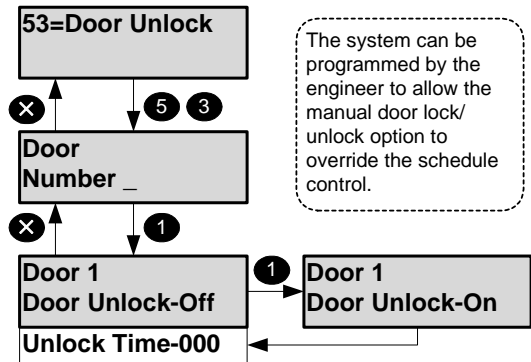

**Door Lockout** **Code-54**

This option will only be available if at least one ACM is fitted to the system. The locked out ACM door will remain locked and will refuse all access attempts until the lockout is removed. The ACM door lockout can only be removed through this programming option. The ACM door lockout will over-ride any user/ACM schedule permissions or otherwise immediately, and for the applied duration. Upon removal the ACM door will be returned to its previous state (if that state still applies). Proximity reader LED's will show the ACM door as locked out for the applied duration.

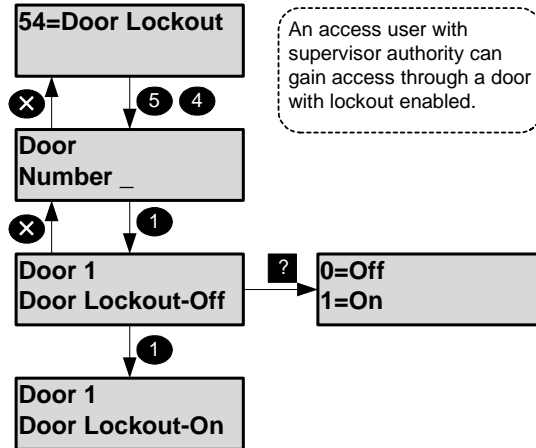

**ACM Text** **Code-55**

A descriptor of up to 10 characters may be entered for each ACM. Refer to the appendix B for details of how to change a descriptor.

**Appendix A – User Authorities**

All user options with the appropriate authority level are shown in the table.

Code	Menu Option	Manager	Ordinary	Set/Uns	Set	Unset	Cleaner	Access	ATM	Log	Bank Reset	Guard
01	Unset	✓	✓	✓	X	✓	✓	X	✓	X	X	X
02	Set	✓	✓	✓	✓	X	✓	X	✓	X	X	X
03	Reset	✓	✓	✓	X	X	X	X	X	X	✓	X
04	Test	✓	✓	X	X	X	X	X	X	X	X	X
05	Engineer	1	1	1	1	X	X	X	X	X	X	X
06	Code	✓	2	2	2	X	X	X	X	X	X	X
07	User	✓	X	X	X	X	X	X	X	X	X	X
08	Tel Number	✓	X	X	X	X	X	X	X	X	X	X
10	Log-Full	✓	X	X	X	X	X	X	X	✓	✓	✓
11	Log-Cct	✓	X	X	X	X	X	X	X	✓	✓	✓
12	Log-User	✓	X	X	X	X	X	X	X	✓	✓	✓
13	Log-KP	✓	X	X	X	X	X	X	X	✓	✓	✓
14	Log-Date	✓	X	X	X	X	X	X	X	✓	✓	✓
15	Log-Alarm	✓	X	X	X	X	X	X	X	✓	✓	✓
16	A/Log-Full	✓	X	X	X	X	X	X	X	✓	✓	✓
17	A/Log-User	✓	X	X	X	X	X	X	X	✓	✓	✓
18	A/Log-ACM	✓	X	X	X	X	X	X	X	✓	✓	✓
20	Time	3	3	X	X	X	X	X	X	X	X	X
24	Holiday	✓	X	X	X	X	X	X	X	X	X	X
25	Schedule	7	X	X	X	X	X	X	X	X	X	X
26	Group Text	✓	X	X	X	X	X	X	X	X	X	X
27	Minutes Left	X	X	X	X	X	X	X	✓	X	X	X
28	Late Work	✓	X	X	X	X	X	X	X	X	X	X
30	Bypass	4	4	X	X	X	X	X	X	X	✓	X
32	Chime	✓	✓	X	X	X	X	X	X	X	X	X
33	Shunt	✓	✓	X	X	X	X	X	X	X	X	X
40	Print Text	5	X	X	X	X	X	X	X	X	X	X
42	Print Hols.	5	X	X	X	X	X	X	X	X	X	X
50	Add A/User	6	X	X	X	X	X	X	X	X	X	X
51	Delete User	6	X	X	X	X	X	X	X	X	X	X
52	Identify User	✓	X	X	X	X	X	X	X	X	X	X
53	Door Unlock	6	X	X	X	X	X	X	X	X	X	X
54	Door Lockout	6	X	X	X	X	X	X	X	X	X	X
55	ACM Text	6	X	X	X	X	X	X	X	X	X	X
71	Copy User	✓	X	X	X	X	X	X	X	X	X	X
73	Copy A/User	✓	X	X	X	X	X	X	X	X	X	X
89	Cct Status	✓	X	X	X	X	X	X	X	X	X	X

Notes:

1. The Engineer option is not available to a user if the panel is programmed to allow the engineer to log on without user authorisation.
2. The code option for some users will only be available if configured as part of the user authority.
3. The time can only be changed by a user if programmed by the engineer. User time changes are limited to +/- 75 minutes.
4. The bypass option is only available if at least one circuit has been programmed to allow bypass.
5. The print options are only available if a printer is connected to the system.
6. The access options are only available if an ACM is fitted to the system
7. The schedule option is only available if programmed by the engineer.

**Appendix B – Editing Text**

A number of text descriptors may be changed by an authorised user. All changes to descriptors are logged.

Item	Max. Length	Default
User	10	User xx
Set group	10	Group x
Access control module	10	ACM x

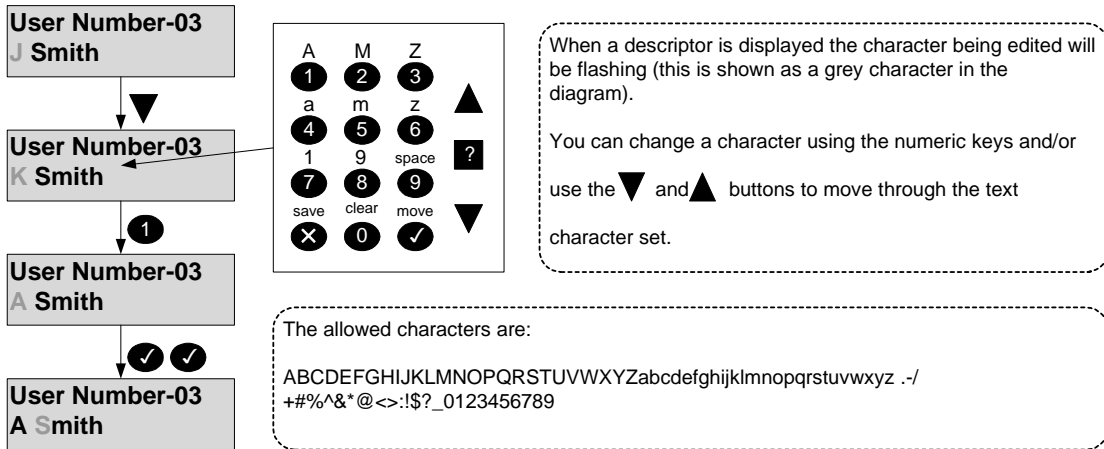

### Appendix C - Log Messages

Alarm & Event Log messages			
Log Text	Additional Data	Display Text	Event Description
230v Fault	NONE (see note)	NONE	Mains supply failed
230v OK	NONE (see note)	NONE	Mains supply restored
A/Set Fault	Usnn, Area m	Usnn, Am	An area auto set with faults
Active Circuit	Circuit nnn	Cctnnn	User selected active circuit test
Alarm	Circuit nnn	Cctnnn	A Circuit alarm
Alarm (master shunt)	Circuit nnn	Cctnnn	Master shunt type circuit alarms
Alarm Abort	User nn, Keypad m	Usnn, KPm	Alarm abort signal transmitted.
Anti mask	Circuit nnn	Cctnnn	A Circuit program with the anti-mask option has alarmed
Auth. Fail	User nn	Usnn	Encryption authentication fail
Auto Check Fail	Circuit nnn	Cctnnn	A Circuit has failed to activate during the auto check period.
Auto Check OK	NONE	NONE	Circuit Auto Check was OK
Bat. Restore	NONE (see note)	NONE	The battery voltage is normal after a battery low
Bat.Monitor Fail	NONE (see note)	NONE	Battery voltage is low or not present during a battery test
Battery Low	NONE (see note)	NONE	The battery has reached the low volts threshold (after a mains fail)
Battery Low	Transmitter number	TXm	Transmitter battery low
Bypass	User nn, Circuit mmm	Usnn Cctmmm	Circuit bypassed
Cannot set	User nn, Area m	Usnn, Am	User was not able to set an area
Cct Tested	Circuit nnn	Cctnnn	Circuit responded in walk test
Changed Code	User nn, Keypad m	Usnn, KPm	User changes own code
Changed Code	User nn, User mm	Usnn, Usmm	Manager or GSR user changes code for another user
Changed Time	User nn, Keypad m	Usnn, KPm	Time modified, old time and new time are logged
Check Fuse	n	N	Panel fuse number
Check Fuse	Conc n	Conc n	Concentrator fuse
Check Fuse	OPM n	OPM n	Output module fuse
Check Fuse	ACM n	ACM n	ACM fuse
Clear	Circuit nnn	Cctnnn	Master shunt type circuit clears
Clear	Circuit nnn	Cctnnn	A Circuit alarm has cleared.
Code Clash	User nn, User mm	Usnn, Usmm	User has chosen a new code which is the same as another user
Comm Acknowledge	n	N	Central station acknowledge alarm report
Comm Fail	NONE	NONE	Control panel comm fail input active.
Comm Fail	n	N	Central station fails to acknowledges alarm report
Comm Fail	Module name	Module name	Module has reported a communications fail
Comm Test	User nn, Keypad m	Usnn, KPm	User or the panel tested the communicator(s)
Commission Fail	User nn	Usnn	Encryption commission fail
Commissioned	User nn	Usnn	Encryption commission OK
Data Route Fail	NONE	NONE	A call using the Dual comm data route has failed.
Data Route OK	NONE	NONE	A call using the Dual comm data route was successful.
Date Changed	Usnn	Usnn	Date changed (manual or auto)

Alarm & Event Log messages			
Log Text	Additional Data	Display Text	Event Description
Det Test Fail	Usnn, Area m	Usnn, Am	One or more detector test circuits failed
Det Test OK	Usnn, Area m	Usnn, Am	All detector test circuits tested OK
Det.Test Fail	User nn, Circuit mmm	Usnn Cctmmm	A detector circuit has failed to respond during a detector test.
Dorm Confirm	Circuit nnn	Cctnnn	Dormitory circuit confirmed
Dorm Init.	Circuit nnn	Cctnnn	Dormitory circuit first activation
Download Fail	GSRx	GSRx	Download from GSR x failed
Download OK	GSRx	GSRx	Download from GSR x OK
Enc.Sequence	User nn	Usnn	Encryption sequence fail
Engineer Reset	Circuit nnn	Cctnnn	Engineer reset type circuit alarms
Entry Alarm	Area n	An	The area is not unset before the end of the entry warning period
Entry Started	Circuit nnn	Cctnnn	Entry circuit opens
Expiry Date	Usnn	Usnn	Config change: User expiry date change.
Ext.Time	User nn, Keypad m	Usnn, KPm	ATM user selected a time extension
Failed Auto Set	User nn, Area m	Usnn, Am	Event programmer failed to auto set due to circuits in alarm
Fault	Radio module number	RM nn	Radio Module fault (no response when unset). The system fault response option must be programmed. This option is only available in EN50131 compliant variants.
Fault	Circuit nnn	Cctnnn	A Circuit short circuit when unset
Fault	Keypad n	KPn	Failed poll when unset
Fault	Conc nn	Conc nn	Failed poll when unset
Fault	OPM nn	OPM nn	Failed poll when unset
Fault	SM n	SM n	Failed poll when unset
Fault	ACM nn	ACM nn	Failed poll when unset
Fire	Circuit nnn	Cctnnn	A fire type circuit alarm
Fire Door Open	Circuit nnn	Cctnnn	Fire door open when unset
First code	User nn, Keypad m	Usnn, KPm	User entered code on Dual code keypad
GSM Route Fail	NONE	NONE	A call using the Dual comm GSM route has failed.
GSM Route OK	NONE	NONE	A call using the Dual comm GSM route was successful.
GSR Poll Fail	GSRx	GSRx	GSR number x poll fail.
GSR Poll Rest.	GSRx	GSRx	GSR number x polling restarted
GSR Rejected	NONE	NONE	A call from an unauthorised GSR was rejected by the panel (the serial number was not programmed)
Head Count	Number		Number of activations of all circuits programmed with the head count option while the panel was unset.
Incorrect PIN	Keypad n	KPn	Maximum PIN attempts reached
Isol. Limit	Area n	An	The isolate limit for the system has been reached.
Isolate	User nn, Circuit mmm	Usnn Cctmmm	Circuit isolated by user
Isolate	User nn, Conc m	Usnn, m	Concentrator isolated by user

Alarm & Event Log messages			
Log Text	Additional Data	Display Text	Event Description
Isolate	User <i>nn</i> , Keypad <i>m</i>	Us <i>nn</i> , KP <i>m</i>	Keypad isolated by user
Isolate	User <i>nn</i> , RM <i>m</i>	Us <i>nn</i> , RM <i>m</i>	Radio module isolated by user
Jamming	Radio module number	RM <i>nn</i>	Receiver jammed
Key Fail	User <i>nn</i>	Us <i>nn</i>	Encryption key fail
Knock	Circuit <i>nnn</i>	Cct <i>nnn</i>	Circuit first knock
Late Working	Us <i>nn</i> , Area <i>m</i>	Us <i>nn</i> , A <i>m</i>	Late working has been selected for the area
Line Fault	Module name	Module name	Module has reported a line fault
Lockout	Keypad <i>n</i>	KP <i>n</i>	Incorrect code attempt limit reached on the keypad
Logged Off	User <i>nn</i> , Keypad <i>m</i>	Us <i>nn</i> , KP <i>m</i>	User logged off keypad
Logged On	User <i>nn</i> , Keypad <i>m</i>	Us <i>nn</i> , KP <i>m</i>	User logged on keypad
Managed Rst	Keypad <i>m</i>	KP <i>m</i>	Managed reset code entered
Marginal	Circuit <i>nnn</i>	Cct <i>nnn</i>	A Circuit is marginal
Mult. Alarm	Circuit <i>nnn</i>	Cct <i>nnn</i>	Circuit has alarmed up to the multiple alarm limit
Normal	User <i>nn</i> , Conc <i>m</i>	Us <i>nn</i> , <i>m</i>	Isolate removed from a concentrator
Normal	User <i>nn</i> , Circuit <i>mmm</i>	Us <i>nn</i> Cct <i>mmm</i>	Bypass or isolate removed from a circuit
Not Unset	Area <i>n</i>	A <i>n</i>	A set group was not unset by the schedule close time
Panel Tamper	NONE	NONE	Panel case or off the wall tamper
PC Access	GSRx Operator YY	GSRx Operator YY	GSR operator number YY has logged on from GSR number x.
PC Disconnect	GSRx Operator YY	GSRx Operator YY	GSR operator number YY has logged on from GSR number x.
Personal Attack	Circuit <i>nnn</i>	Cct <i>nnn</i>	A PA type circuit alarm
Poll Fail	Transmitter number	TX <i>nn</i> , RM <i>mm</i>	Transmitter polling failure
Poll Fault	Radio module number	RM <i>nn</i>	Receiver polling fault
Power Fail	NONE (see note)	NONE	Supply voltage has fallen to the power fail threshold
PSTN Route Fail	NONE	NONE	A call using the Dual comm PSTN route has failed.
PSTN Route OK	NONE	NONE	A call using the Dual comm PSTN route was successful.
Remote Service	GSRx	GSRx	Remote Service Complete
Reprogrammed	Refer to table	Refer to table	Item menu description plus optional number (see note)
Reset	Circuit <i>nnn</i>	Cct <i>nnn</i>	An area has been reset
Reset	User <i>nn</i> , Area <i>m</i>	Us <i>nn</i> , Us <i>nn</i>	An area has been reset
Restored Code(s)	User <i>nn</i> , Keypad <i>m</i>	Us <i>nn</i> , KP <i>m</i>	All codes have been restored to default
Rmt.Auth Fail	NONE	NONE	Repeated attempt to log on by a remote host
Session End	User <i>nn</i>	Us <i>nn</i>	Encryption session end
Set	User <i>nn</i> , Area <i>m</i>	Us <i>nn</i> A <i>m</i>	Area has been set by a user
Set	User <i>nn</i> , Group <i>m</i>	Us <i>nn</i> <i>m</i>	Group has been set by a user
Set Req.	Circuit <i>nnn</i>	Cct <i>nnn</i>	Key type circuit alarms
Set Req.	User <i>nn</i> , Keypad <i>m</i>	Us <i>nn</i> , KP <i>m</i>	A user requested set on a keypad (dual set programmed)
Shunt Limit	Area <i>n</i>	A <i>n</i>	The shunt limit for the system has been reached.
Shunt Off	User <i>nn</i> , Circuit <i>mmm</i>	Us <i>nn</i> Cct <i>mmm</i>	Shunted removed from circuit
Shunt On	User <i>nn</i> , Circuit <i>mmm</i>	Us <i>nn</i> Cct <i>mmm</i>	Shunt applied to circuit

Alarm & Event Log messages			
Log Text	Additional Data	Display Text	Event Description
Sndr Tamper	NONE	NONE	Panel sounder tamper
Soak Alarm	Circuit <i>nnn</i>	Cct <i>nnn</i>	A circuit on soak test has alarmed
Soak Failed	Circuit <i>nnn</i>	Cct <i>nnn</i>	At the end of the soak period any circuit which has alarmed is logged as failed
Soak Off	Circuit <i>nnn</i>	Cct <i>nnn</i>	A circuit has been taken off soak
Soak On	Circuit <i>nnn</i>	Cct <i>nnn</i>	A circuit has been put on soak
Software Error	N	N	A software error has been logged
Tamper	<i>n</i>	<i>n</i>	Concentrator Tamper
Tamper	Circuit <i>nnn</i>	Cct <i>nnn</i>	A circuit tamper
Tamper	Keypad <i>n</i>	KP <i>n</i>	A keypad tamper
Tamper	SM <i>n</i>	SM <i>n</i>	A serial module tamper
Tamper	OPM <i>n</i>	OPM <i>n</i>	An output module tamper
Tamper	ACM <i>n</i>	ACM <i>n</i>	An ACM tamper
Tamper	Radio module number	RM <i>nn</i>	Radio Module tamper
Temp Bypass	Circuit <i>nnn</i>	Cct <i>nnn</i>	A circuit has been temporarily (until clear) bypassed
TX Off	N	N	TX channel N off
TX On	N	N	TX channel N on
Unset	User <i>nn</i> , Area <i>m</i>	Us <i>nn</i> A <i>m</i>	A user has unset the area
Unset	User <i>nn</i> , Group <i>m</i>	Us <i>nn</i> <i>m</i>	Group has been unset by a user
Unset Req.	Circuit <i>nnn</i>	Cct <i>nnn</i>	Key type circuit clears
Unset Req.	User <i>nn</i> , Keypad <i>m</i>	Us <i>nn</i> , KP <i>m</i>	A user requested unset on a keypad (dual unset or unset delay programmed)
Upload Fail	GSRx	GSRx	Upload to GSR x failed
Upload OK	GSRx	GSRx	Upload to GSR x OK
Verify Alm	Area <i>n</i>	A <i>n</i>	A verified alarm has occurred
Watchdog	NONE	NONE	Software watchdog active

**Appendix C – Access Log Messages**

Access Control log only messages			
Log Text	Additional Data	Display Text	Event Description
Access	User <i>nn</i> , ACM <i>m</i>	Us <i>nn</i> , ACM <i>m</i>	User accessed ACM m
Card Exit	User <i>nn</i> , ACM <i>m</i>	Us <i>nn</i> , ACM <i>m</i>	User exit by ACM m, which has no door contact
Denied	User <i>nn</i> , ACM <i>m</i>	Us <i>nn</i> , ACM <i>m</i>	User denied access ACM m
Door Open	ACM <i>m</i>	ACM <i>m</i>	ACM door held open
Exit	User <i>nn</i> , ACM <i>m</i>	Us <i>nn</i> , ACM <i>m</i>	User exit by ACM m
Forced	ACM <i>m</i>	ACM <i>m</i>	ACM door forced open
Lock	ACM <i>m</i>	ACM <i>m</i>	ACM door lock
Pending	ACM <i>m</i>	ACM <i>m</i>	Schedule unlock pending
RTE	ACM <i>m</i>	ACM <i>m</i>	ACM Door RTE button active
Set Req.	User <i>nn</i> , ACM <i>m</i>	Us <i>nn</i> , ACM <i>m</i>	User request to set from ACM m
Unlock	ACM <i>m</i>	ACM <i>m</i>	ACM door unlocked
Unset Req.	User <i>nn</i> , ACM <i>m</i>	Us <i>nn</i> , ACM <i>m</i>	User request to unset from ACM m

**Appendix E - Menu Restrictions**

If a menu number is entered and the option is not available, then a reason will be displayed. For example if no area is set and you select unset the panel will prompt with the reason the unset option is not available.

**Not Available  
No Set Area**

*This indicates that there is no set area available to the user.*

There are many reasons why an option is not available. If you think an option should be available but the prompt is not on display then enter the menu number and the panel will display an appropriate message. The following table shows the reasons why a menu option is not available:

<b>Not Available Message</b>	<b>Where Used</b>
At Bypass Limit	User attempts to bypass a circuit when the number of bypassed circuits is at the programmed bypass limit.
Call Engineer	User attempts to set when an engineer reset is required.
High Level Set	User attempts to unset a lower level group without unset higher levels
Isolate Limit	User attempts to isolate a circuit when the maximum allowed number of circuits are already isolated
Isolated	User attempts to bypass a circuit that is isolated.
Key Not Used	The key (button) which has been pressed is never used in the current menu.
Keypad Busy	User attempts to turn off a keypad that is being used.
Low Level Unset	User attempts to set a higher level group without setting lower levels
No Authority	User tries to select an option that is not allowed with their programmed authority level.
No Set Area	User selects unset when all areas that can be unset from the keypad are already unset.
No Unset Area	User selects set when all areas that can be set from the keypad are already set.
Not Applicable	User attempts, for example, to reset when there are no alarms logged.
Not Programmed	The option selected is not programmed.
Option in Use	User selects an option, such as test, which is in being used by another user.
Printer Busy	User attempts to print and the printer is in use.
Set Area	User attempts to access test when an area is set.
Shunt Limit	User attempts to shunt a circuit when the maximum allowed number of circuits are already shunted
System Not Unset	User attempts to access an option that is only available when the system is unset, for example the event log.
Test in Progress	User attempts to set an area that is being tested (on another keypad).
Test System	Circuit check fail has occurred and the user has selected set
Timer Control On	User attempts to log on outwith the schedule times.
Unset Area	User attempts to unset an unset area.

**Appendix E - Log On Messages**

When a user logs on, the system may display a special message(s) before the normal menu is displayed. The special messages are shown in the table.

<b>Message</b>	<b>Reason</b>
Alarm Abort	User logs on within the alarm abort period (programmable option)
Call Engineer	You should call the installation company. The details will then be displayed.
Cannot Set	The system cannot set, the reason(s) will then be displayed.
Code Known	Another user has chosen your code. You will then be given the option of immediately changing your code. This message will always be displayed on log on until the code is changed.
Det.Test Fail Area x	A detector in area x has failed an automatic detector test. Note that this warning will not be shown if the log on set option applies.
Group Unset	A group(s) is set and is programmed to automatically unset when a user logs on.
Mult.Alarm	A circuit(s) has alarmed the maximum number of times allowed (programmable). The circuit details will then be displayed.
Reset OK	A managed reset code has been accepted
Setting Stopped	User logs on during the setting exit period
Soak Cct Fails	Circuits which have been put on special test by the installation engineer have alarmed.
Unset Alarm	An unset alarm has occurred, the details will then be displayed.

## Appendix F – Audio Commands

This section only applies to systems that are fitted with an audio bus or a speech module. The speech and audio functions of the system by using a DTMF telephone handset. To use an audio or speech function:

1. Dial the control panel telephone number
2. Log on using your PIN code and terminate with the # button
3. Enter the required function code

Code	Meaning
*01# - *32#	Activate TalkBack modules 1 to 32
*00#	Activate all TalkBack modules
#	Toggle between listen and talk modes
*59#	Replay stored audio (the system must be fitted with an audio interface with the speech record option)
*40#	Record main message
*41# - *49#	Record channel messages 1 to 8
*410#	Record set message
*411#	Record unset message
*50#	Play main message
*51# - *59#	Play channel message 1 to 8
*510#	Play set message
*511#	Play unset message
*61# - *68#	Turn on output 1 to 8 (the selected output must be programmed by the engineer)
*171# - *178#	Turn off output 1 to 8 (the selected output must be programmed by the engineer)
*010#	Unset system
*01nn#	Unset group n, where n = 1 to 32
*020#	Set system
*02nn#	Set group n, where n = 1 to 32
*03nn#	Status of set group n, where n = 1 to 32
*	Cancel command
*#	shut down call

Note that all commands except toggle are preceded with a “\*” and you must wait for the confirm tone after the “\*” before pressing “#”.

Message	Length (seconds)	Function
0	8	Main message sent with all speech format alarm reports
1-8	4	Channel messages sent when the corresponding channel is active
9	6	Memo message or stored audio message

**Appendix G - System Details**

Number of Areas	
Number of keypads	
Number of Circuits	
Number of Users	
Service Number	
Contract Number	

**Keypads**

Number	Location
1	
2	
3	
4	
5	
6	
7	
8	

**Set Groups**

Number	Description	Areas							
		1	2	3	4	5	6	7	8
1									
2									
3									
4									
5									
6									
7									
8									

**Circuits**

Number	Description	Location
Cct 1		
Cct 2		
Cct 3		
Cct 4		
Cct 5		
Cct 6		
Cct 7		
Cct 8		
Cct 9		
Cct 10		
Cct 11		
Cct 12		
Cct 13		
Cct 14		
Cct 15		
Cct 16		
Cct 17		
Cct 18		
Cct 19		
Cct 20		
Cct 21		
Cct 22		
Cct 23		
Cct 24		
Cct 25		
Cct 26		
Cct 27		

Number	Description	Location
Cct 28		
Cct 29		
Cct 30		
Cct 31		
Cct 32		
Cct 33		
Cct 34		

**Users**

Number	Description	Areas			
		1	2	3	4
2					
3					
4					
5					
6					
7					
8					



Guardall Limited  
Lochend Industrial Estate  
Newbridge  
Edinburgh EH28 8PL

Tel: 0131-333-2900  
FAX: 0131-333-4919

Technical Hotline: 0131-333-3802

Part Number: 320995-0B